

Low Power CO₂ Sensor

DESCRIPTION

The CozIR®-LP3 is a low power NDIR CO₂ sensor using state-of-the-art solid-state LED optical technology. The low power LEDs are manufactured in-house, giving GSS complete control of the CO₂ sensor signal chain.

The CozIR®-LP3's low power consumption is compatible with battery powered operation, allowing the sensor to be used in a wide variety of applications including wirelessly connected equipment.

The CozIR®-LP3 operation is configurable depending on user requirements. On power-up, the CozIR®-LP3 automatically starts taking measurements. Measurements can be streamed or output on request.

The CozIR®-LP3 also features a built-in auto-zero function that maintains CO₂ measurement accuracy over the lifetime of the product.

FEATURES

- Low power <3mW average
- 30ppm typical measurement accuracy
- Solid state NDIR LED optical technology
- UART or I²C control and data interface
- Analogue or digital CO₂ measurements
- Built-in auto-zeroing
- Altitude pressure compensation
- Programmable alarm output

APPLICATIONS

- Air Quality and HVAC
- Building management systems (BMS)
- Demand-Controlled Ventilation (DCV) systems
- IoT and Smart Technology wireless equipment
- Indoor Air Quality (IAQ) equipment

BLOCK DIAGRAM

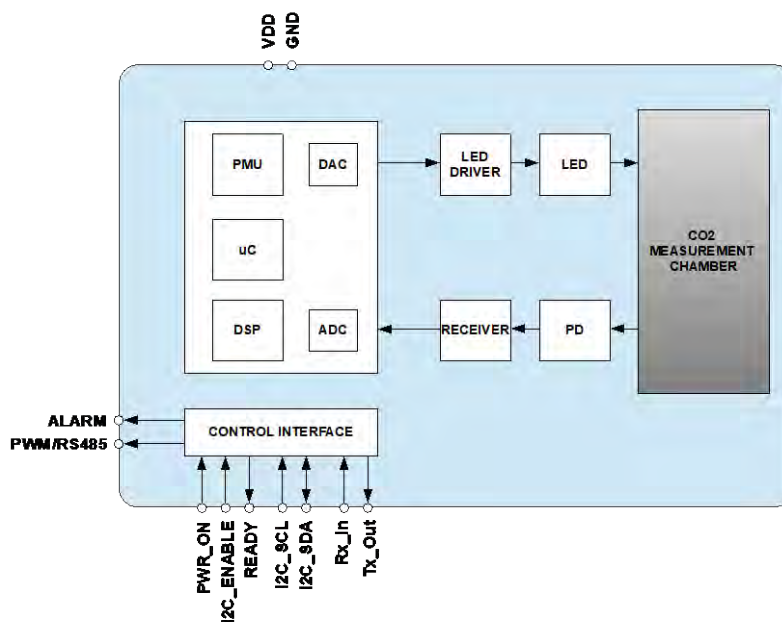

Low Power CO₂ Sensor

TABLE OF CONTENTS

DESCRIPTION.....	1
BLOCK DIAGRAM.....	1
FEATURES.....	1
APPLICATIONS.....	1
ORDERING INFORMATION.....	4
PACKAGE DRAWING.....	5
PIN-OUT DESCRIPTION – CozIR®-LP3.....	6
ABSOLUTE MAXIMUM RATINGS.....	8
RECOMMENDED OPERATING CONDITIONS.....	8
PERFORMANCE CHARACTERISTICS.....	9
ELECTRICAL CHARACTERISTICS – RX_IN, TX_OUT, SDA, SCL, I2C_ENABLE, READY.....	10
ELECTRICAL CHARACTERISTICS – PWM_RS485, ALARM Outputs.....	10
ELECTRICAL CHARACTERISTICS – PWR_ON Input.....	10
POWER CONSUMPTION.....	11
METHOD OF OPERATION.....	12
POWER ON DATA READY.....	12
MEASUREMENT CYCLE.....	14
MEASUREMENT CYCLE - I ² C INTERFACE MODE.....	15
MEASUREMENT CYCLE - UART INTERFACE MODE.....	15
MEASUREMENT PROCESS.....	15
DIGITAL FILTER.....	16
PWM_RS485 - DIGITAL OUTPUT.....	18
PWM Output Configuration.....	18
High/Low Configuration.....	18
ALARM OUTPUT.....	19
BUILT-IN SELF TEST.....	19
ZERO POINT SETTING.....	20
ZERO IN A KNOWN GAS CONCENTRATION.....	20
ZERO IN NITROGEN.....	20
ZERO IN FRESH AIR.....	20
AUTO-ZERO FUNCTION.....	21
AUTO-ZERO INTERVALS.....	21
AUTO-ZERO LEVEL.....	22
ALTITUDE PRESSURE COMPENSATION.....	23
SELECTION OF CONTROL INTERFACE.....	24
CONTROL INTERFACE TIMING - I ² C MODE.....	24
I ² C INTERFACE MODE.....	25
WRITING TO AN I ² C REGISTER.....	26
READING FROM AN I ² C REGISTER.....	26
I ² C REGISTER MAP SUMMARY.....	27
MEASUREMENT CONTROL.....	29
CO ₂ LEVEL MEASUREMENT VALUE WITH STATUS BYTE.....	29

Low Power CO₂ Sensor

CO ₂ LEVEL MEASUREMENT VALUE ONLY.....	29
DIGITAL FILTER	29
ZERO CONTROL SETTINGS.....	30
AUTO-ZERO INITIAL INTERVAL PERIOD	31
AUTO-ZERO INTERVAL PERIOD	31
AUTO-ZERO TARGET VALUE	31
ZERO IN FRESH AIR.....	32
CONTROL VALUE	32
SERIAL NUMBER.....	32
ALARM LEVEL	32
PWM CONTROL.....	33
AUTO-ZERO CONTROL	33
SELF-TEST	34
RUN TIME	34
ALTITUDE PRESSURE SETTING.....	34
CONNECTION DIAGRAM FOR I ² C INTERFACE.....	35
UART INTERFACE MODE	36
CONTROL INTERFACE TIMING - UART MODE	36
UART COMMAND PROTOCOL.....	36
UART OPERATION	36
METHOD OF OPERATION	37
K0 COMMAND MODE (K=0).....	37
K1 STREAMING MODE (K=1)	37
K2 POLLING MODE (K=2).....	37
K COMMAND.....	37
K COMMAND (0x4B)	38
MEASUREMENT DATA OUTPUTS	38
UART INTERFACE SUMMARY	39
CO ₂ LEVEL MEASUREMENT VALUE - Z INFORMATION (0x5A)	42
CO ₂ LEVEL MEASUREMENT VALUE - z INFORMATION (0x7A)	42
CO ₂ MEASUREMENT Z SCALING FACTOR – UART MODE.....	42
‘.’ COMMAND (0x2E).....	42
DIGITAL FILTER COMMANDS	43
A COMMAND (0x41)	43
a COMMAND (0x61).....	43
ZERO SETTING COMMANDS – UART MODE	44
G COMMAND (0x47)	45
U COMMAND (0x55).....	45

Low Power CO₂ Sensor

X COMMAND (0x58)	45
P COMMAND - CO ₂ Level for Auto-Zeroing	45
P COMMAND – CO ₂ Level for Zero-Point Setting.....	46
SENSOR STATUS AND CONFIGURATION COMMANDS – UART MODE	47
i COMMAND.....	47
J COMMAND (0x4A).....	47
j COMMAND (0x6A)	47
ALTITUDE PRESSURE COMPENSATION	48
[COMMAND (0x5B)	48
] COMMAND (0x5D).....	48
AUTO-ZERO INTERVALS.....	49
@ COMMAND (0x2E).....	49
SERIAL NUMBER AND FIRMWARE VERSION – UART MODE.....	50
Y COMMAND (0x59).....	50
c COMMAND (0x63).....	50
CONNECTION DIAGRAM FOR UART INTERFACE	51
IMPORTANT NOTICE	52
ADDRESS	53

ORDERING INFORMATION

CozIR®-LP3-X

X	Measurement Range
2000	2000ppm
5000	5000ppm
1	10,000ppm (1%)

See separate data sheet for CozIR®-LP3 evaluation kit options.

Notes:

1. Sensors are shipped individually or in trays
2. Tray quantity = 50

Low Power CO₂ Sensor

PACKAGE DRAWING

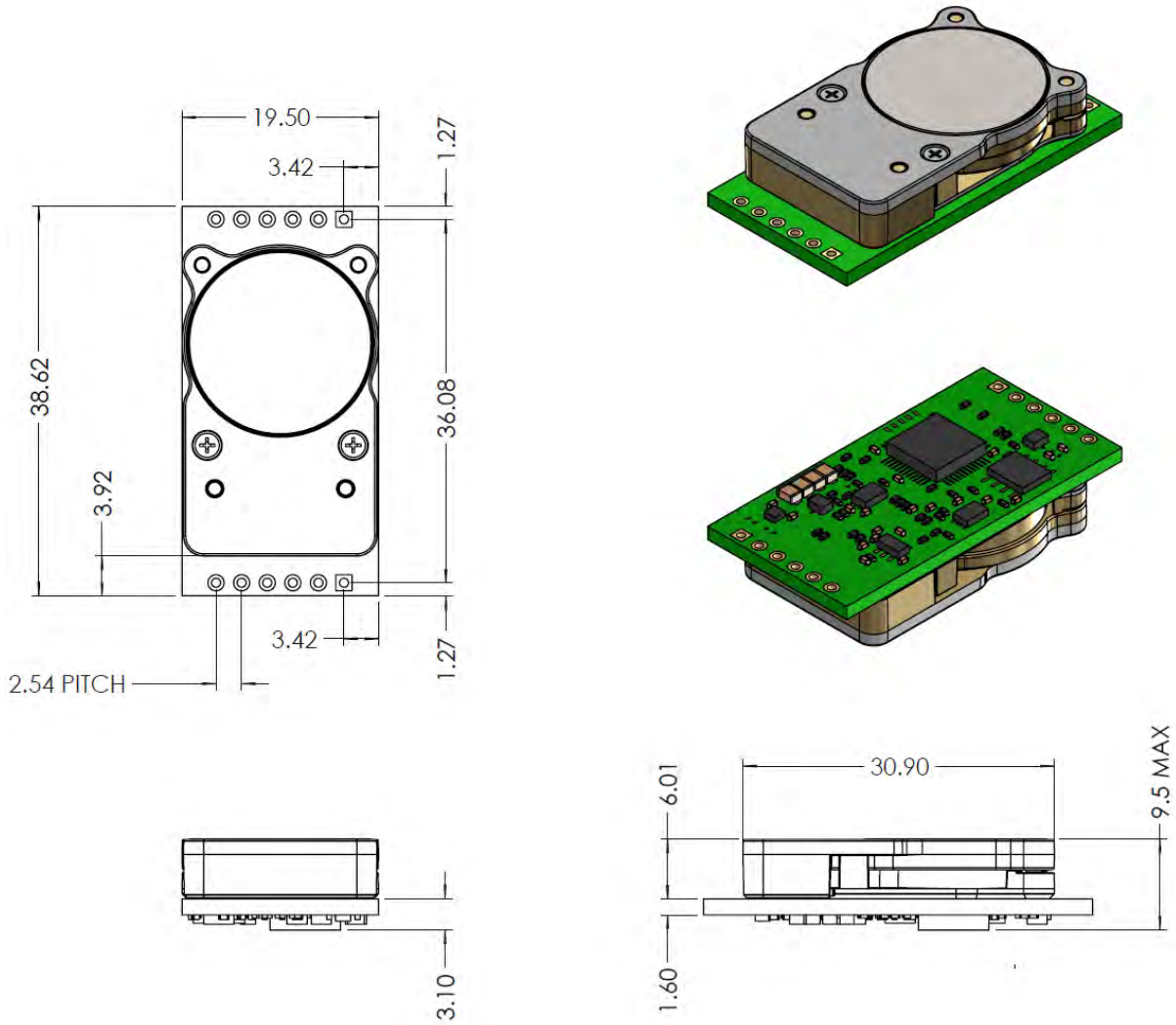

Weight = ~5g

Low Power CO₂ Sensor

PIN-OUT DESCRIPTION – CozIR®-LP3

PIN	NAME	TYPE	DESCRIPTION
1	GND	Supply	Sensor ground
2	VDD	Supply	Sensor supply voltage
3	NC	Unused	Do not connect (For internal use only)
4	PWR_ON	Digital Input	Sensor Power on Enable pin. - Power on – High - Power off – Low If unused, connect to VDD
5	ALARM	Digital Output	Alarm Output
6	READY	Digital Output	Data ready pin. Pulsed high when data ready
7	PWM_RS485	Digital Output	PWM Output Or Direction control to drive external half duplex RS485 transceiver
8	I2C_ENABLE	Digital Input	Set low for I ² C interface mode. Leave floating to select UART interface mode. Pin status detected at power on.
9	I2C_SCL	Digital Input	I ² C serial clock input. Open drain, external 4.7kΩ resistor pulled high to VDD required
10	I2C_SDA	Digital Input/Output	I ² C serial data input/output. Open drain, external 4.7kΩ resistor pulled high to VDD required
11	Tx_Out	Digital Output	UART Transmit Output
12	Rx_In	Digital Input	UART Receive Input

Top View

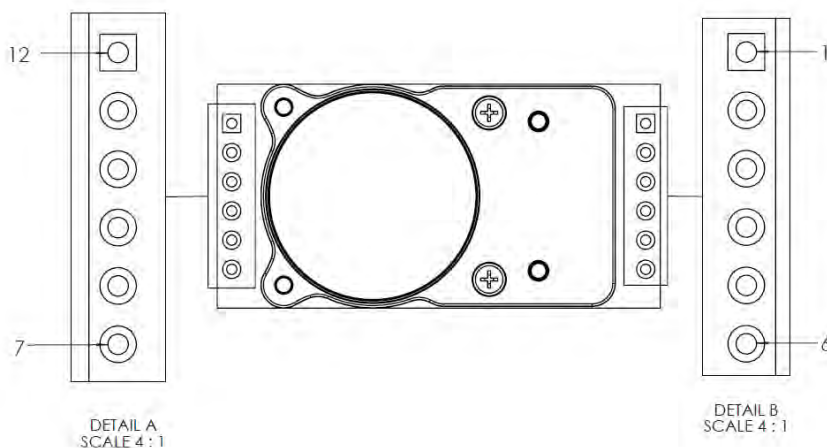

Low Power CO₂ Sensor

CONNECTION DIAGRAM

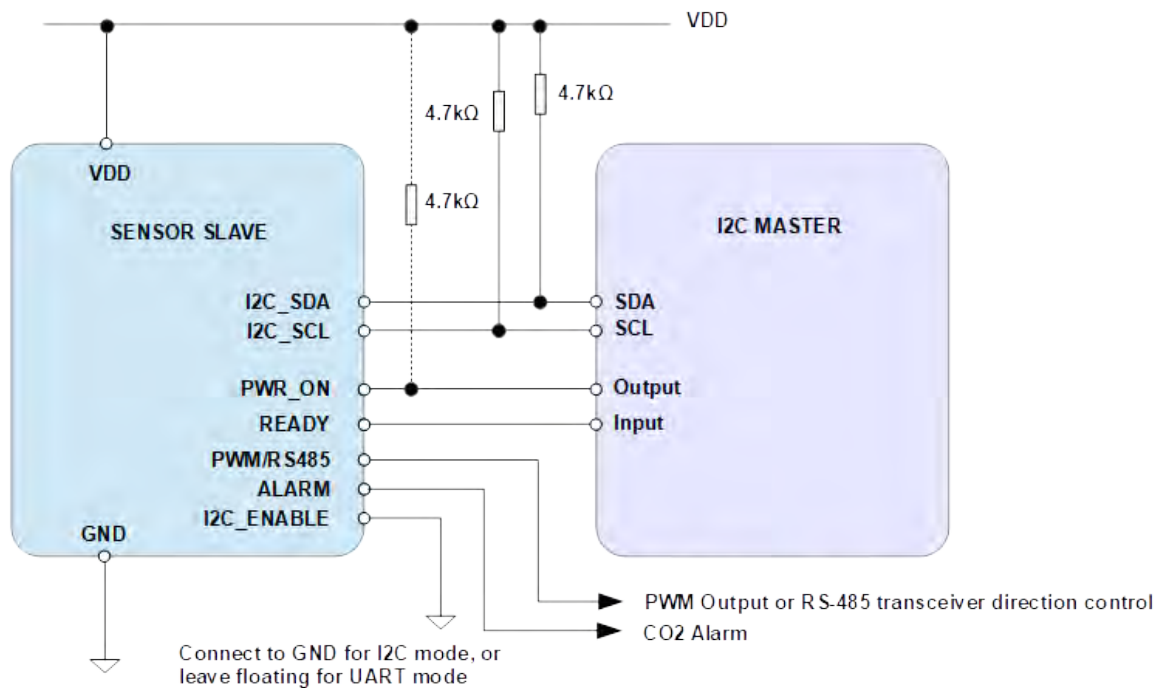

Notes

1. The power on status of the sensor can be controlled with the PWR_ON pin. If this function is not required, the pin must be pulled high to VDD

Low Power CO₂ Sensor

ABSOLUTE MAXIMUM RATINGS

Absolute Maximum Ratings are stress ratings only. Permanent damage to the CozIR®-LP3 may be caused by continuously operating at or beyond these limits. The CozIR®-LP3 functional operating limits and guaranteed performance specifications are given at the test conditions specified.



ESD Sensitive Device. This sensor uses ESD sensitive components. It is therefore generically susceptible to damage from excessive static voltages. Proper ESD precautions must be taken during handling and storage of this device.

CONDITION	MIN	MAX
Supply Voltages	-0.3V	+6.0V
Voltage Range Digital Inputs	GND -0.3V	5V
Operating Temperature Range (T _a)	0°C	+50°C
Storage Temperature Range	-40°C	+70°C
Humidity Range (RH), non-condensing	0	95%
Operating Pressure Range	500mbar	2bar

RECOMMENDED OPERATING CONDITIONS

PARAMETER	SYMBOL	MIN	TYP	MAX	UNIT
Supply	VDD	3.25	3.3	5.5	V
Ground	GND		0		V

Low Power CO₂ Sensor

PERFORMANCE CHARACTERISTICS

Test Conditions Unless Otherwise Specified

 VDD = 3.3V, GND = 0V. CO₂ = 450ppm, RH = 0% non-condensing, T= 25°C, Pressure = 1013mbar

PARAMETER	SYMBOL	TEST CONDITIONS	MIN	TYP	MAX	UNIT
CO ₂ measurement range			0		2,000	ppm
			0		5,000	ppm
			0		10,000	ppm
Accuracy		@25°C		±(30, +3% of reading)	±(45, +3% of reading)	ppm
		0°C to +50°C, after auto-zero @25°C		±(30, +3%), +0.14% per °C		ppm
CO ₂ RMS Noise		Digital filter setting 16		6		ppm
Time to Valid Measurement After Power-On		Dependent on filter setting, typ @ 16	0.8	8.3		secs
Response Time		From 0ppm to T ₉₀ (half full-scale), default settings, limited by diffusion through membrane window		30		secs
Repeatability				±(30, +3%)		ppm
Pressure Dependence		Per mbar deviation from 1013mbar, 750-1050mbar		0.14		%
Current Consumption		Peak current when sampling		15		mA
		Peak at turn-on		40		mA
		SLEEP Mode		0.01		mA

Low Power CO₂ Sensor

ELECTRICAL CHARACTERISTICS – RX_IN, TX_OUT, SDA, SCL, I2C_ENABLE, READY

PARAMETER	SYMBOL	TEST CONDITIONS	MIN	TYP	MAX	UNIT
Digital Input/Output						
Input HIGH Level			1.8			V
Input LOW Level					1.0	V
Output HIGH Level		I _{OH} = +1mA	2.6			V
Output LOW Level		I _{OL} = -1mA			0.4	V

ELECTRICAL CHARACTERISTICS – PWM_RS485, ALARM Outputs

PARAMETER	SYMBOL	TEST CONDITIONS	MIN	TYP	MAX	UNIT
Digital Input/Output						
Output HIGH Level		I _{OH} = +1mA	2.6			V
Output LOW Level		I _{OL} = -1mA			0.4	V

ELECTRICAL CHARACTERISTICS – PWR_ON Input

PARAMETER	SYMBOL	TEST CONDITIONS	MIN	TYP	MAX	UNIT
Digital Input/Output						
Input HIGH Level			0.9			V
Input LOW Level					0.4	V

Low Power CO₂ Sensor

POWER CONSUMPTION

Test Conditions Unless Otherwise Specified

VDD = 3.3V, GND = 0V. CO₂ = 450ppm, RH = 0% non-condensing, T= 25°C, Pressure = 1013mbar

SETTING	SYMBOL	TEST CONDITIONS	VDD		Average Power
			V	I (mA)	mW
Active OFF		PWR_ON held low	3.3	0.001	0.003
Active, SLEEP mode, no measurements			3.3	0.01	0.03
Active, taking measurements		Default settings	3.3	1	3.5

The CozIR®-LP3 current consumption varies in time over the measurement cycle. The LED is pulsed, which results in a peak current when taking measurements of approximately 15mA. A typical current consumption profile after power-on is shown below.

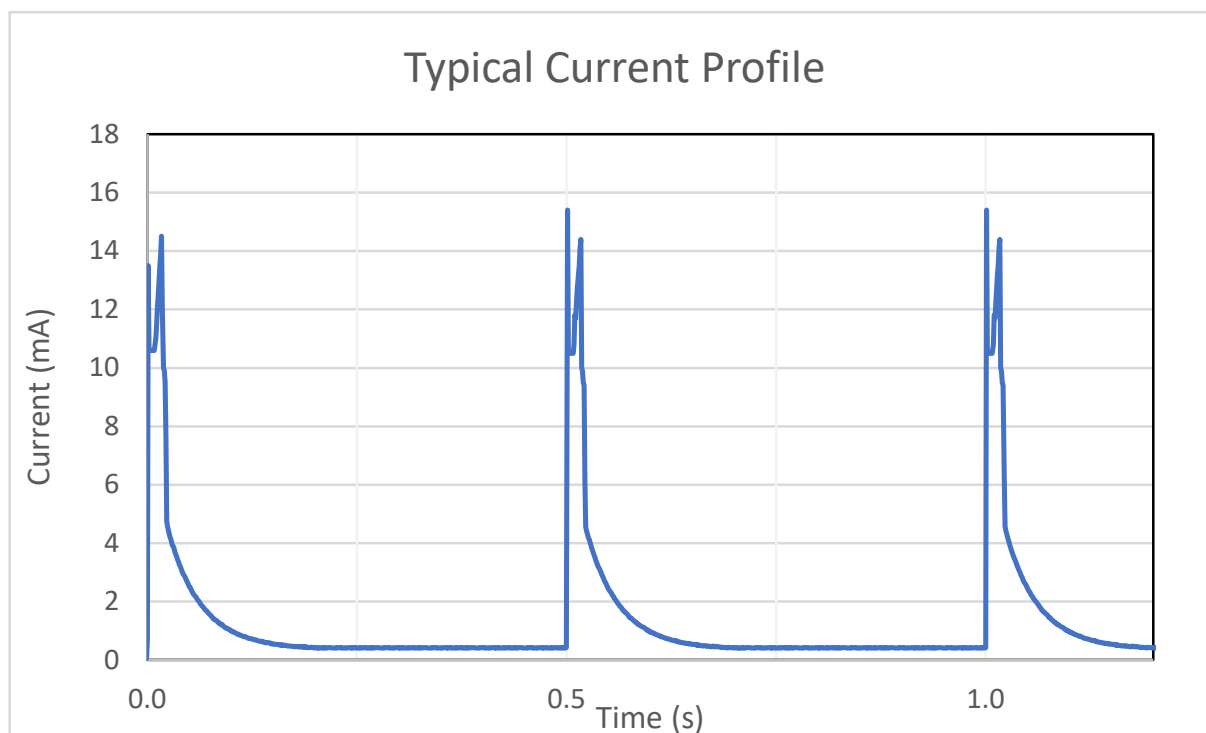

Low Power CO₂ Sensor

METHOD OF OPERATION

The CozIR®-LP3 is designed for low power applications where power is often at a premium.

Power-on is controlled by setting the state of the PWR_ON pin. This pin controls the on-board sensor power. If held low, the sensor will remain in a quiescent state. The sensor will not respond to any commands in this state. To turn the sensor on, set PWR_ON pin high. If unused, connect the PWR_ON pin permanently to VDD.

When the sensor is switched on, and the PWR_ON pin connected to VDD or set high, the state of the I2C_ENABLE pin is sampled. Setting the I2C_ENABLE pin low puts the CozIR®-LP3 into I²C interface mode. Leaving the I2C_ENABLE pin floating puts the CozIR®-LP3 into UART interface mode.

In either mode, after power on, the sensor automatically starts to take measurements, 2 readings per second. Readings can be read out once the READY pin is pulsed high in either UART or I²C interface mode.

POWER ON DATA READY

After power is applied to the CozIR®-LP3, the sensor will automatically start to take CO₂ measurements using the configured settings. Once the initial READY flag has been pulsed high, the sensor will respond to requests for CO₂ data. The control interface is available approximately 14ms after the falling edge of a valid READY pulse.

The data READY time is determined by the digital filter setting.

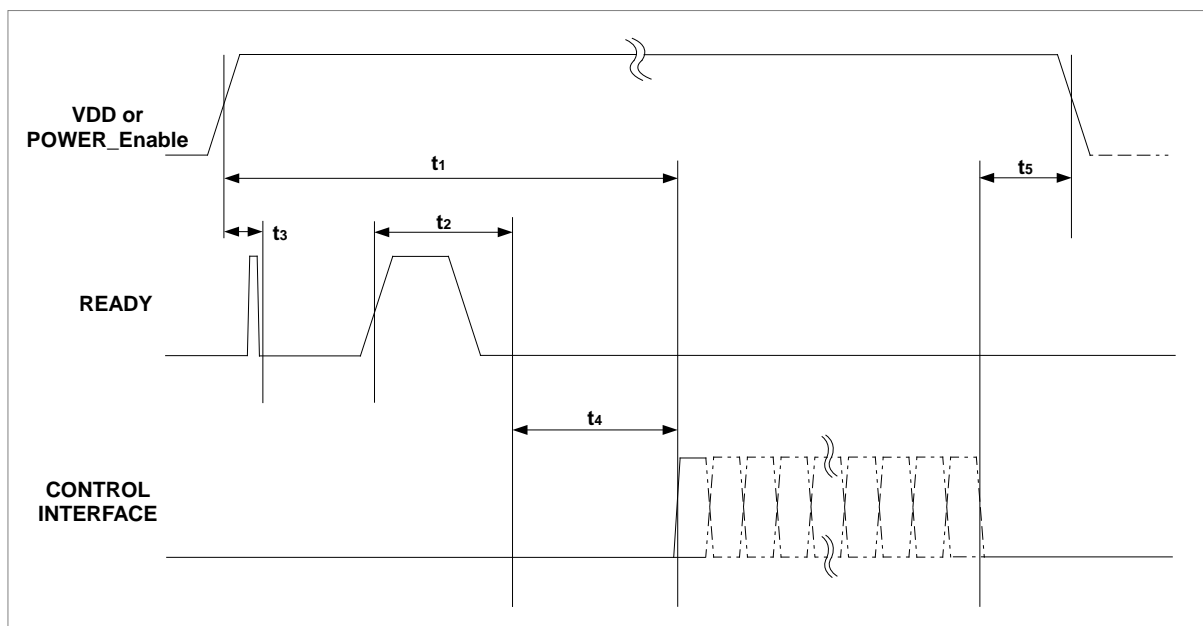

Low Power CO₂ Sensor

PARAMETER	SYMBOL	MIN	TYP	MAX	UNIT
READY Data Valid from Power On	t ₁	0.8	8.3		s
READY High Pulse-Width	t ₂		16.5		ms
READY Low from Power On	t ₃			100	ms
Control Interface Setup Time	t ₄	14			ms
Control Interface Active to Safe Shutdown Time ¹	t ₅	228	5.8		ms

Notes

1. Time needed for the sensor to safely shut down after the user has written to or read from memory.

Low Power CO₂ Sensor

MEASUREMENT CYCLE

Writing to or reading from the CozIR®-LP3 sensor is gated by the status of the READY pin. In both UART and I²C interface mode, the sensor will not respond when the READY pin is high. The READY pin is set high for approximately 16.5ms when the sensor is taking measurements every 0.5 seconds. The control interface is available approximately 14ms after the falling edge of a valid READY pulse. The sensor will only respond correctly when the READY pin is low.

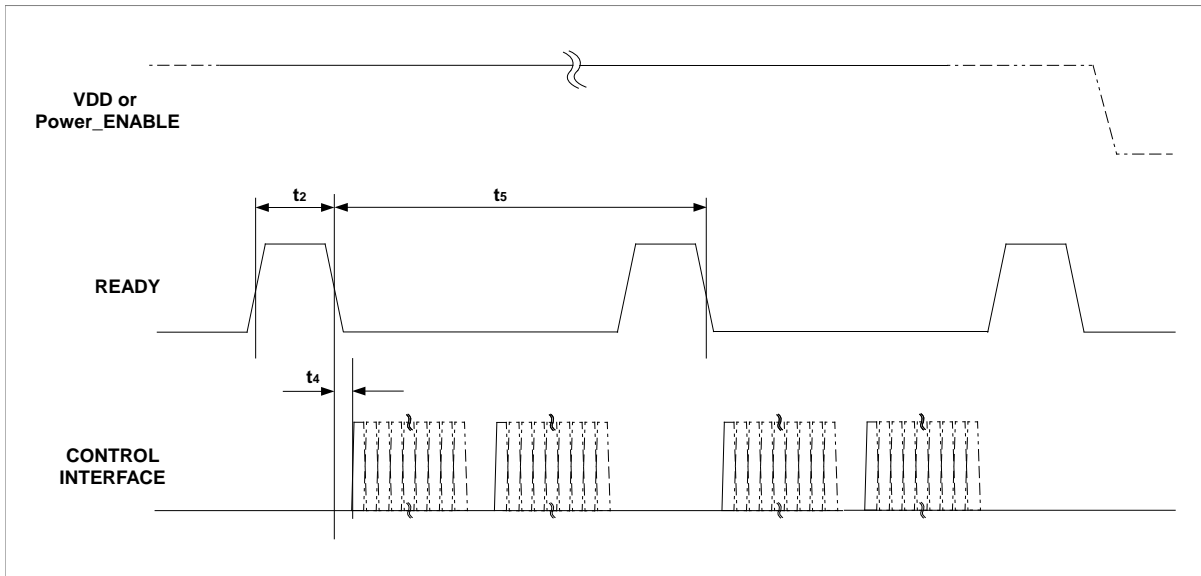

PARAMETER	SYMBOL	MIN	TYP	MAX	UNIT
READY High Pulse-Width	t_2		16.5		ms
Control Interface Setup Time	t_4	14			ms
READY Pulse Period	t_5		0.5		s

Low Power CO₂ Sensor

MEASUREMENT CYCLE - I²C INTERFACE MODE

- Apply power to the Sensor and set PWR_ON high
- The sensor will automatically start taking measurements.
- The data READY flag is set low within 5ms of power on.
- The data READY flag will be pulsed high for approximately 16.5ms with data available 14ms after the falling edge of the data READY flag
- Data can be read out at any rate up to the maximum I²C read rate
- Measurement data is updated every 0.5 seconds
- Note when auto-zero is used, the auto-zero trigger event will extend the measurement time by ~2s

MEASUREMENT CYCLE - UART INTERFACE MODE

- Apply power to the Sensor and set PWR_ON high
- The sensor will automatically start taking measurements.
- The sensor takes a measurement at 2 readings per second
- The data READY flag is set low within 5ms of power on.
- The data READY flag will be pulsed high for approximately 16.5ms with data available 14ms after the falling edge of the data READY flag
- The UART baud rate is fixed at 9600 baud
- Measurement data is updated every 0.5 seconds
- Note when auto-zero is used, the auto-zero trigger event will extend the measurement time by ~2s

MEASUREMENT PROCESS

The CozIR®-LP3 sensor takes readings at a fixed rate of two per second. The measurement process is set on by default but can be switched off to save power. If the measurement process is switched off, the user can still write to control registers to configure the sensor. The sensor will report the last active measurement until the measurement process is switched back on. The time to a valid measurement will depend on the sensor filter configuration.

Low Power CO₂ Sensor

DIGITAL FILTER

The CO₂ gas chamber is illuminated with a nominal 4.25um wavelength LED and the signal received using a photo-diode. The signal from the photo-diode is processed and filtered by the sensor to remove noise and provide an accurate CO₂ reading. High frequency noise coming from the sampling process is removed using a proprietary lowpass filter. The digital filter setting can be varied from 1-255, allowing the user to reduce measurement noise at the expense of the measurement response time. Filter = 1 is the same as unfiltered.

The ideal digital filter setting is application specific and is normally a balance between CO₂ reading accuracy and response time. Filter settings are variable between The CozIR®-LP2 sensor will also output the raw unfiltered CO₂ measurement data. This data can be post processed using alternative filter algorithms.

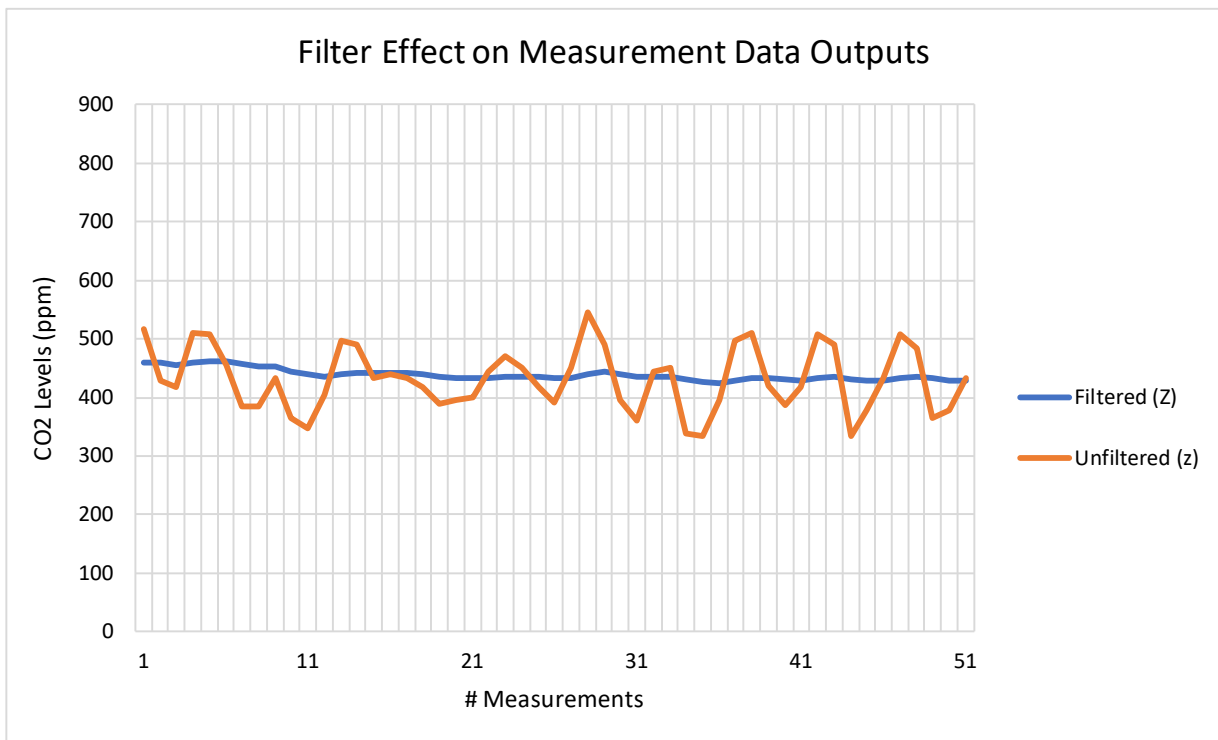

The graph above shows the effects of the filter on the CO₂ measurement data (Z). The unfiltered output (z) is shown in orange and the filtered output (Z) shown in blue.

Low Power CO₂ Sensor

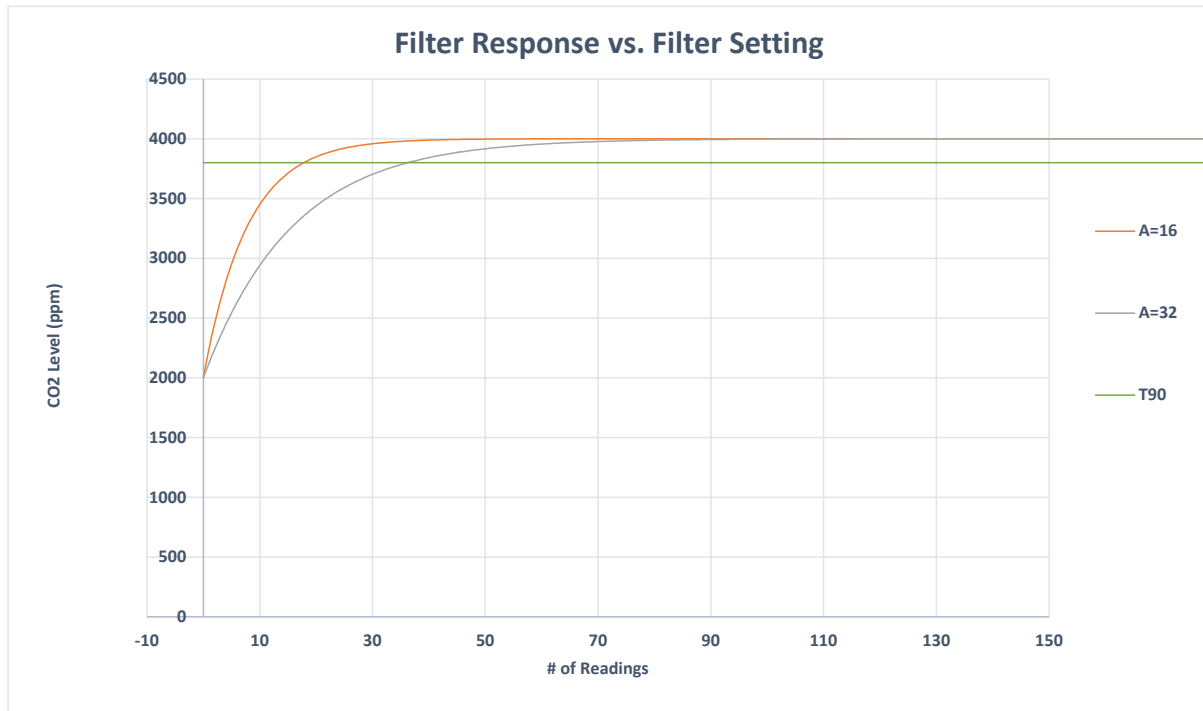

The graph above shows the effect of the filter on response times. Increasing the filter setting increases the measurement output response time. T_{90} is the time to 90% of reading. The CozIR®-LP3 takes 2 readings per second. The CozIR®-LP3 sensor will also output the raw unfiltered CO₂ measurement data. This data can be post processed using alternative filter algorithms.

Low Power CO₂ Sensor

PWM_RS485 - DIGITAL OUTPUT

PWM/RS485 is an independently controlled digital output. The PWM_RS485 pin can be configured in two different ways, selectable by the user.

PWM Output Configuration

This mode must be selected by the user. The PWM output is OFF by default. Once selected, the digital output is configured as a PWM output with the duty cycle proportional to the CO₂ concentration, from 0 to full scale.

The PWM output is only operational when the sensor is active. The default PWM master clock rate is 8MHz. Provision is made to divide the master clock by powers of 2 up to 128. The PWM resolution may be set to 8 or 10 bits.

The PWM signal can be programmed to be continuously on or pulsed on to save power.

In pulsed mode, the user can set the PWM output to pulse on after every measurement cycle. The number of pulses is programmable from 2 pulses to 8 pulses.

If the measured CO₂ concentration is lower than 1 bit of output, the PWM pin will stay low. If the measured CO₂ concentration is higher than all bits set, the PWM pin will stay high.

Clock Speed	8-bit PWM frequency (kHz)	10-bit PWM frequency (kHz)
Min	0.244	0.061
Max	31.25	7.81

The PWM configuration is retained after the sensor is power cycled.

High/Low Configuration

This mode must be selected by the user. Once selected, this digital output can be set high or low and can be used for a variety of functions including for example setting the direction control for an external RS-485 physical layer transceiver.

Low Power CO₂ Sensor

ALARM OUTPUT

The sensor comes with a CO₂ level alarm function. The ALARM pin goes high if the detected CO₂ level exceeds the alarm threshold value. The alarm threshold detection can be enabled or disabled. It is disabled by default.

If enabled, the alarm is triggered when the measured CO₂ reading exceeds the alarm threshold value. The alarm is cleared if the measured CO₂ reading falls below 80% of the alarm threshold value.

The alarm is off if the CO₂ level alarm level is set to zero. The default setting is zero.

The alarm value is retained after the sensor is power cycled.

BUILT-IN SELF TEST

The sensor has a built-in test function that automatically checks if it is operating correctly at power-on and during a measurement cycle. The sensor will store an error condition if any of the following are triggered.

ERROR FLAG	ERROR CONDITION
Sensor Lifetime	If the total power-on time exceeds 20000 hours
LED optical output value	If LED output is out of range
CO ₂ out of range	If the temperature compensated CO ₂ value is out of range
ADC input value	If the ADC input signal is out of the expected range

The sensor will return a self-test decimal value of 85 if operation is nominal or 170 if any of the error conditions are flagged.

Low Power CO₂ Sensor

ZERO POINT SETTING

The performance of an NDIR sensor can be compromised by the build-up of contaminants in the measurement chamber of the sensor, as well as other degradations in the optical components. The effect of these degradations can be fully eliminated by using one or more of the GSS zeroing routines. Zero-point setting is the process of modifying the CO₂ measurement value read by the sensor and align it with an external reference set point.

In all cases, the best zero is obtained when the gas concentration is stable, and the sensor is at a stabilised temperature. Zero-point settings are not cumulative and only the latest zero-point setting is effective. For example, there is no benefit in zeroing in nitrogen, and then zeroing in a calibration gas. The sensor will store only the latest zero point regardless of what method is used. There are a several different methods available to the user to set the zero point of the sensor.

ZERO IN A KNOWN GAS CONCENTRATION

Place the sensor in a known gas concentration and allow time for the sensor temperature to stabilise, and for the gas to be fully diffused into the sensor.

Power up the sensor, wait for the READY pin to indicate the sensor interface is active. Write the known concentration level to the sensor, then initiate the Zero in a Known Gas calibration method. The concentration must be in ppm.

ZERO IN NITROGEN

Place the sensor in the nitrogen gas and allow time for the sensor temperature to stabilise, and for the gas to be fully diffused into the sensor. Power up the sensor, wait for the READY pin to indicate the sensor interface is active. Initiate the Zero in Nitrogen command. The sensor is zeroed assuming a 0ppm CO₂ environment.

ZERO IN FRESH AIR

If there is no calibration gas or nitrogen available, the sensor zero point can be set in fresh air. Ambient CO₂ concentrations in fresh air are typically 400ppm. This level is programmable over a range from 0ppm to the full scale of the sensor.

Place the sensor in a fresh air environment and allow time for the sensor temperature to stabilise, and for the fresh air to be fully diffused into the sensor. Power up the sensor, wait for the READY pin to indicate the sensor interface is active.

The user can initiate a Zero in Fresh Air setting cycle. The sensor can use the default fresh air CO₂ concentration value (400ppm), or the user can write a different fresh air value to the sensor if desired. The concentration must be in ppm.

Low Power CO₂ Sensor

AUTO-ZERO FUNCTION

The sensor has a built-in auto-zeroing function. To function correctly, the sensor must be exposed to typical background levels (400-450ppm) at least once during the auto-zero period. For example, many buildings will drop quickly to background CO₂ levels when unoccupied overnight or at weekends. The auto-zero function uses the information gathered during these periods to re-zero. The sensor will reset the 'zero' level every time it does an auto-zero. Auto-zeroing is enabled by default. If the sensor is powered down, the auto-zero is reset to default values.

The auto-zero function works in the same way as the **ZERO IN FRESH AIR** command. Auto-zeroing is enabled by default. It is enabled to operate automatically but can be disabled or it can be forced. The user can also independently adjust the CO₂ level used for auto-zeroing.

The CoZIR®-LP3 keeps a record of the lowest measured CO₂ value in memory (Z_{lowest}). The sensor also keeps a record of the last CO₂ measurement. Every time the CoZIR®-LP3 takes a new measurement, the previous and current values are filtered to create a new value (Z_{new}).

$$Z_{new} = \frac{Z_{cur} - Z_{prev}}{2} + Z_{prev}$$

If the value of Z_{new} is lower than the stored Z_{lowest} , Z_{lowest} is updated.

When the auto-zero function is run, the sensor will reset the fresh-air zero point using Z_{lowest} . The value the sensor uses for this fresh-air zero-point is user programmable. The sensor default value for CO₂ in fresh air is 400ppm. When the auto-zero function is run, the sensor sets the Z_{lowest} value of CO₂ of the fresh air to 400ppm. Typically, it is set to the same value as the **ZERO IN FRESH AIR** value, but it can also be set at a different level if desired.

AUTO-ZERO INTERVALS

The auto-zero period can be programmed by the user. The sensor can be programmed to undertake an initial auto-zero after power-on. Thereafter, the auto-zero period can be set independently of the start-up auto-zero time. Note, the auto-zero settings are reset if the sensor is powered down.

The minimum and maximum interval time for either the initial or ongoing auto-zero period depends on the interface mode.

Low Power CO₂ Sensor

UART Mode

Auto-Zero Period	Minimum Value	Maximum Value	Default Value	Resolution
Initial Auto-Zero	0.1 days	37.9	7 days	0.1 day
On-Going Auto-Zero	0.1 days	37.9	8 days	0.1 day

I²C Mode

Auto-Zero Period	Minimum Value	Maximum Value	Default Value	Resolution
Initial Auto-Zero	0	65535	12096	1
On-Going Auto-Zero	0	65535	13824	1

In I²C mode, the time period is calculated as follows.

Auto-Zero (hours) = Auto-Zero Value/72

Initial Auto-Zero (default) = 12096/72 = 168 hours (7 days)

On-Going Auto-Zero (default) = 13824/72 = 192 hours (8 days)

In all cases, it is recommended the subsequent auto-zero period is set to >1 day and the initial auto-zero period set to less than the subsequent auto-zero period.

AUTO-ZERO LEVEL

The background concentration will depend on sensor location. Ambient levels are typically in the range of 400ppm - 450ppm. The factory default is set to 400ppm. The user can change the background ambient level used for auto-zeroing. The value is stored in the sensor.

Low Power CO₂ Sensor

ALTITUDE PRESSURE COMPENSATION

NDIR gas sensors detect the concentration of gas by measuring the degree of light absorption by the gas analyte. The degree of light absorption is then converted into a concentration reported by the sensor.

The absorption process is pressure dependent, and a change in pressure will cause a change in the reported gas concentration. As the pressure increases, the reported gas concentration also increases. As the pressure decreases, the reported concentration decreases. This effect takes place at a molecular level and is common to all NDIR gas sensors.

GSS sensors are calibrated at 1013mbar. The reading from the sensor will vary from the nominal output if the mean barometric pressure is different from the calibration setting.

It is possible to configure the sensor to correct for this effect by writing the actual or reference mean barometric pressure in mbar to the sensor. This can be done as part of the initial set up process or updated at any time during use.

Low Power CO₂ Sensor

SELECTION OF CONTROL INTERFACE

The CozIR®-LP3 is controlled by writing to registers through a serial control interface. The control interface can be configured as a UART or 2-wire I²C interface.

Selection of the control interface is done via the I2C_ENABLE pin. The state of the I2C_ENABLE pin is sampled at power up only. The status cannot be changed after power up. Setting the I2C_ENABLE pin low puts the CozIR®-LP3 into I²C interface mode. Leaving the I2C_ENABLE pin floating puts the CozIR®-LP3 into UART control interface mode.

CONTROL INTERFACE TIMING - I²C MODE

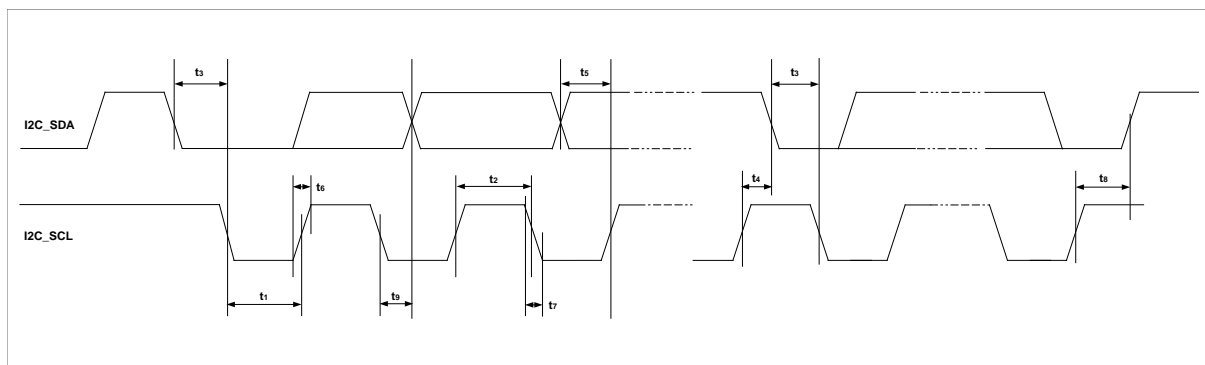

PARAMETER	SYMBOL	MIN	TYP	MAX	UNIT
I2C_SCL Frequency		0		100	kHz
I2C_SCL Low Pulse-Width	t ₁	4.7			us
I2C_SCL High Pulse-Width	t ₂	4.0			us
Hold Time (Start Condition)	t ₃	4.0			us
Setup Time (Start Condition)	t ₄	4.7			us
Data Setup Time	t ₅	250			ns
I2C_SDA, I2C_SCL Rise Time	t ₆			1000	ns
I2C_SDA, I2C_SCL Fall Time	t ₇			300	ns
Setup Time (Stop Condition)	t ₈	4.0			us
Data Hold Time	t ₉	0		5.0	us
Capacitive load for each bus line	-			400	pF

Low Power CO₂ Sensor

I²C INTERFACE MODE

The CozIR®-LP3 supports software control via a 2-wire serial bus. Many devices can be controlled by the same bus, and each device has a unique 7-bit address (this is not the same as the 8-bit address of each register in the CozIR®-LP3). The CozIR®-LP3 operates as a slave only device.

The controller indicates the start of data transfer with a high to low transition on I2C_SDA while I2C_SCL remains high (I²C Start condition). This indicates that a device address will follow. All devices on the 2-wire bus respond to the start condition and shift in the next eight bits on I2C_SDA (7-bit address + Read/Write bit, MSB first). If the device address received matches the address of the CozIR®-LP3 and the R/W bit is '0', indicating a write, then the CozIR®-LP3 responds by pulling I2C_SDA low on the next clock pulse (ACK). If the address is not recognised or the R/W bit is '1', the CozIR®-LP3 returns to the idle condition and waits for a new start condition and valid address.

The CozIR®-LP3 acknowledges the correct address by pulling I2C_SDA low for one clock pulse. The master then sends the address of the register it wishes to read from or write to. Data is either read from or written to in 1 - 4 bytes, most significant byte (MSB) first.

The transfer of data is complete when there is a low to high transition on I2C_SDA while I2C_SCLK is high. After receiving a complete address and data sequence the CozIR®-LP3 returns to the idle state and waits for another start condition. If a start or stop condition is detected out of sequence at any point during data transfer (i.e. I2C_SDA changes while I2C_SCL is high), the device jumps to the idle condition.

The CozIR®-LP3 supports clock stretching. In an I²C communication, the master device determines the clock speed. The I²C bus provides an explicit clock signal running at a pre-defined rate. However, there are situations where an I²C slave is not able to co-operate with the clock speed given by the master and needs to slow down a little. This is done by a mechanism referred to as *clock stretching*.

An I²C slave is allowed to hold down the clock if it needs to reduce the bus speed. The CozIR®-LP3 operates at up to 100kHz, and maximum stretch is never more than 500usecs.

The CozIR®-LP3 device address is 0x41.

Low Power CO₂ Sensor

WRITING TO AN I²C REGISTER

The controller (Master) sends a START condition to the sensor. The sensor acknowledges the controller by setting the R/W bit low, indicating it is expecting the controller to write to a register. The controller sends the register address that it wants to write to, and then 1-4 data bytes. Once the controller has completed the operation, it sends the STOP condition.

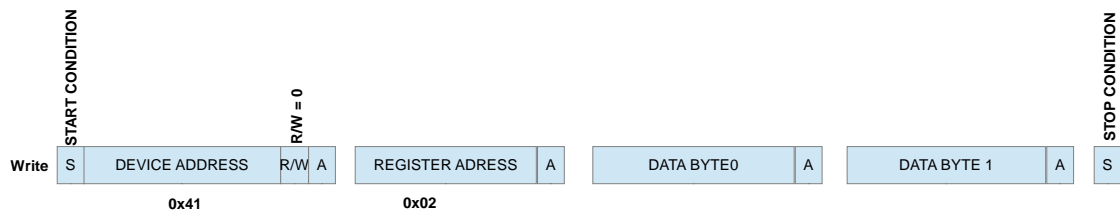

READING FROM AN I²C REGISTER

The controller (Master) sends a START condition to the sensor. The sensor acknowledges the controller by setting the R/W bit high, indicating it is expecting the controller to read from a register. The controller (Master) must send another START condition to the sensor and the sensor address with R/W bit set to read. Then read out 1-4 data bytes. Once the controller has completed the operation, it sends the STOP condition.

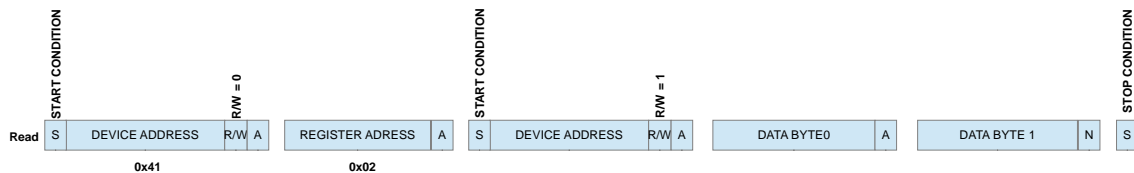

Low Power CO₂ Sensor

I²C REGISTER MAP SUMMARY

REGISTER	ADDRESS	DESCRIPTION	DEFAULT	RANGE	SIZE (bytes)	READ/WRITE
R0 (0x00)	0000000	Measurement Control	2		1	READ/WRITE
R2 (0x02)	0000010	CO ₂ Level (ppm), filtered, with sensor Global Self-Test byte	N/A	0 – 65535	3	READ
R4 (0x04)	0000100	Digital Filter Setting	16	0 - 255	1	READ/WRITE*
R5 (0x05)	0000101	Zero Control Settings			1	WRITE
R6 (0x06)	0000110	Auto Zero Initial Interval Period	12096	0 - 65535	2	READ/WRITE
R8 (0x08)	0001000	Auto Zero Interval Period	13824	0 - 65535	2	READ/WRITE
R12 (0x0C)	0001100	Auto-Zero Target Level	400ppm	0 to full scale	2	READ/WRITE
R18 (0x12)	0010010	Target value for CO ₂ in fresh air (in ppm)	400ppm	0 to full scale	2	READ/WRITE
R20 (0x14)	0010100	New target value in fresh air in ppm (for zero settings)			2	WRITE
R38 (0x26)	0100110	Serial Number	N/A		4	READ
R44 (0x2C)	0101100	Alarm Level	0	0-20000	2	READ/WRITE
R46 (0x2E)	0101110	PWM Control	0	0-255		READ/WRITE
R52 (0x34)	0110100	CO ₂ Level (ppm), filtered	N/A	0 – 65535	2	READ
R78 (0x4E)	1001110	Auto-Zero Control			1	READ/WRITE
R80 (0x50)	1010000	Global Self-Test			1	READ/WRITE
R90 (0x5A)	1011010	Reports Total Number of Hours	N/A	0-65535	2	READ

Low Power CO₂ Sensor

		Run by Sensor Powered Up				
R118 (0x76)	1110110	Altitude pressure in mbar	1013	697 – 1050	2	READ/WRITE

Notes

* indicates a sensor zero should be performed after the default values are changed.

Low Power CO₂ Sensor

MEASUREMENT CONTROL

REGISTER	ADDRESS	BIT	LABEL	DESCRIPTION	DEFAULT	READ/WRITE
R0 (0x00)	00000000	7:0	MEASUREMENT	CO ₂ measurement 00000010 = On 00000000 = Off	00000010	READ/WRITE

If measurements are switched off, all zero setting commands are automatically disabled.

CO₂ LEVEL MEASUREMENT VALUE WITH STATUS BYTE

REGISTER	ADDRESS	BIT	LABEL	DESCRIPTION	DEFAULT	READ/WRITE
R2 (0x02)	00000010	15:0		CO ₂ level, in ppm	N/A	Read only

The measured CO₂ level is read from Register R2. The first two 8-bit bytes are CO₂ measurement data, MSB first. The value is CO₂ level in ppm. Byte 3 can be read as the global self-test error status value or the status can be read from register 80.

CO₂ LEVEL MEASUREMENT VALUE ONLY

REGISTER	ADDRESS	BIT	LABEL	DESCRIPTION	DEFAULT	READ/WRITE
R52 (0x34)	0110100	15:0		CO ₂ level, in ppm	N/A	Read only

The measured CO₂ level is read from Register R52, 2 bytes, MSB first. The value is CO₂ level in ppm

DIGITAL FILTER

REGISTER	ADDRESS	BIT	LABEL	DESCRIPTION	DEFAULT	READ/WRITE
R4 (0x04)	00000100	7:0	FILTER	Digital filter setting	00010000	READ/WRITE

Low Power CO₂ Sensor

ZERO CONTROL SETTINGS

REGISTER	ADDRESS	BIT	LABEL	DESCRIPTION	DEFAULT	READ/WRITE
R5 (0x05)	00000101	0	Air Zero	Sets the zero point assuming the sensor is in 400ppm CO ₂ . If using a different CO ₂ value, write the CO ₂ level into Register 18 prior to initiating the zero process. 000000000: No Zero 000000001: Zero	N/A	Write
		1	Nitrogen Zero	Sets the zero point assuming the sensor is in 100% nitrogen. 000000000: No Zero 000000010: Zero in Nitrogen	N/A	Write
		2	X Zero	Sets the zero point with the sensor in a known concentration of CO ₂ . Write the target ppm concentration into Register 20 prior to initiating the zero process. 00000000: No X Zero 00000010: X Zero	N/A	Write

The control register 5 enables the user to transfer the value stored in register 18 or register 20 into sensor memory. Once the new target value has been written into register 18 or register 20, write to register R5 to complete the data transfer.

Once the new data has been written to memory, register 5 is cleared.

Low Power CO₂ Sensor

AUTO-ZERO INITIAL INTERVAL PERIOD

REGISTER	ADDRESS	BIT	LABEL	DESCRIPTION	DEFAULT	READ/WRITE
R6 (0x06)	00000110	15:0		Sets the auto-zero initial interval count period. Each count is 0.5s.	10111101000000	READ/WRITE

The default initial auto-zero period value 12096, equivalent to 7 days.

AUTO-ZERO INTERVAL PERIOD

REGISTER	ADDRESS	BIT	LABEL	DESCRIPTION	DEFAULT	READ/WRITE
R8 (0x08)	00001000	15:0		Sets the auto-zero interval period	11011000000000	Read/Write

The default auto-zero period value 13824, equivalent to 8 days.

AUTO-ZERO TARGET VALUE

REGISTER	ADDRESS	BIT	LABEL	DESCRIPTION	DEFAULT	READ/WRITE
R12 (0x0C)	00001100	15:0		Sets the target value for CO ₂ level when doing an auto-zeroing	110010000	Read/Write

The user can independently set the target value for CO₂ used for an auto-zero event. The default is 400ppm.

Low Power CO₂ Sensor

ZERO IN FRESH AIR

REGISTER	ADDRESS	BIT	LABEL	DESCRIPTION	DEFAULT	READ/WRITE
R18 (0x12)	00010010	15:0		Target value for CO ₂ in fresh air	110010000	

The target value for CO₂ in fresh air is stored in register 18. The default is 400ppm.

CONTROL VALUE

REGISTER	ADDRESS	BIT	LABEL	DESCRIPTION	DEFAULT	READ/WRITE
R20 (0x14)	00010100	15:0	CONTROL	New target value		Write

Stores the new target value. All CO₂ values are in ppm. Number is a two-byte value, MSB first.

SERIAL NUMBER

REGISTER	ADDRESS	BIT	LABEL	DESCRIPTION	DEFAULT	READ/WRITE
R38 (0x26)	00100110	31:0	SERIAL NUMBER	Unique sensor serial number, 32-digit code		Read only

ALARM LEVEL

REGISTER	ADDRESS	BIT	LABEL	DESCRIPTION	DEFAULT	READ/WRITE
R44 (0x2C)	00101100	15:0	ALARM LEVEL	CO ₂ threshold for alarm. Sets alarm threshold level between 0 -20,000ppm. 0 turns off the alarm. Alarm value retained after power cycle.	0ppm	READ/WRITE

Low Power CO₂ Sensor

PWM CONTROL

REGISTER	ADDRESS	BIT	LABEL	DESCRIPTION	DEFAULT	READ/WRITE
R46 (0x2E)	0101110	2:0	PRESCALAR	Sets clock pre-scaler, in powers of 2.	00	Read/Write
		3	RESOLUTION	0 = 8-bit 1 = 10-bit	0	Read/Write
		4	MODE	0 = Pulsed 1 = Always on	0	Read/Write
		6:5	OUTPUT	00 = Continuous Output 01 = 2 pulses, then sleeps 10 = 4 pulses, then sleeps 11 = 8 pulses, then sleeps	00	Read/Write
		7	ON/OFF	Controls the state of the PWM output	0	Read/Write

AUTO-ZERO CONTROL

REGISTER	ADDRESS	BIT	LABEL	DESCRIPTION	DEFAULT	READ/WRITE
R78 (0x4E)	01001110	7:0	AUTO CAL	Auto-zero control 00000000 = Disabled 00000010 = Enabled	00000010	Read/Write

To force an auto-zero sequence, do the following.

- Set R78 to Enabled
- Set R12 auto-zero to target level, or leave at its default setting
- Set R8 interval period to zero

Low Power CO₂ Sensor

SELF-TEST

REGISTER	ADDRESS	BIT	LABEL	DESCRIPTION	DEFAULT	READ/WRITE
R80 (0x50)	1010000	7:0	GLOBAL SELF TEST	Sensor automatic self-test result 01010101 = Sensor is nominal (decimal value 85) 10101010 = Sensor error (decimal value 170)		Read/Write

RUN TIME

REGISTER	ADDRESS	BIT	LABEL	DESCRIPTION	DEFAULT	READ/WRITE
R90 (0x5A)	1011010	15:0	HOURS	Reports total number of hours sensor powered-up.	N/A	Read

ALTITUDE PRESSURE SETTING

REGISTER	ADDRESS	BIT	LABEL	DESCRIPTION	DEFAULT	READ/WRITE
R118 (0x76)	1110110	15:0	PRESSURE	Pressure in mbar.	1013	Read/Write

Low Power CO₂ Sensor

CONNECTION DIAGRAM FOR I²C INTERFACE

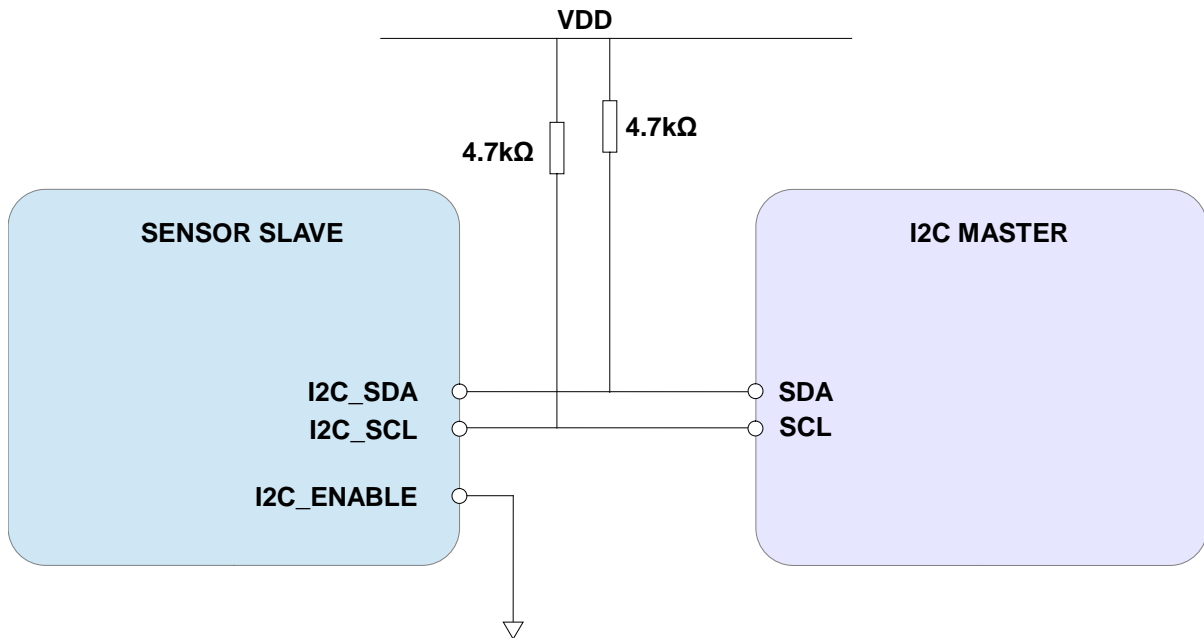

Low Power CO₂ Sensor

UART INTERFACE MODE

Leaving the I2C_ENABLE pin floating puts the CozIR®-LP3 into UART control interface mode. The status of the I2C_ENABLE is only sampled at power up.

The **Rx_In** and **Tx_Out** pins are normally high, suitable for direct connection to a UART. If the sensor is to be read by a true RS232 device (e.g. a PC), it is necessary to use a level converter to step up/down the voltage and invert the signal.

CONTROL INTERFACE TIMING - UART MODE

PARAMETER	SYMBOL	MIN	TYP	MAX	UNIT
Baud Rate (Fixed)			9,600		Bits/s
Data Bits		8			
Parity		None			
Stop Bits		1			
Hardware Flow Control		None			

UART COMMAND PROTOCOL

All UART commands must be terminated with a carriage return and line feed <CR><LF>, hex 0x0D 0x0A. In this document, this is shown as '\r\n'. UART commands that take a parameter always have a space between the letter and the parameter. The sensor will respond with a '?' if a command is not recognised. The two most common causes are missing spaces or missing <CR><LF> terminators.

All command communications are in ASCII and are terminated by carriage return, line feed (0x0D 0x0A). This document uses the protocol "\r\n" to indicate the carriage return line feed. All responses from the sensor, including measurements, have a leading space (ASCII character 32).

The character '#' represents an ASCII representation of a numeric character (0-9). Note there is a space between the first letter and any parameter. For example, the X command reads "X space 2000 carriage return line feed".

UART OPERATION

When initially powered, the sensor will immediately start to transmit a CO₂ reading on receiving any character.

The CO₂ measurement is reported as:

Z #####\r\n

where Z ##### shows the CO₂ concentration.

Note that all outputs from the sensor have a leading space.

Low Power CO₂ Sensor

METHOD OF OPERATION

After power is applied to the CozIR®-LP3, the sensor will automatically start to take CO₂ measurements using the Mode K1 default settings, where the sensor is pre-programmed to send CO₂ measurement data at 2 readings per second. The measurement rate is fixed at 2 readings per second at 9600 baud rate. The sensor will return the previous CO₂ measurement results if the user requests more frequent measurements. The CozIR®-LP3 has 3 potential modes of operation.

K0 COMMAND MODE (K=0)

In this mode, the sensor is in a SLEEP mode, waiting for commands. No measurements are made. There is no latency in command responses. All commands that report measurements or alter the zero-point settings are disabled in Mode 0. Mode 0 is NOT retained after power cycling.

K1 STREAMING MODE (K=1)

This is the factory default setting. Measurements are reported twice per second. Commands are processed when received, except during measurement activity, so there may be a time delay of up to 100ms in responding to commands.

K2 POLLING MODE (K=2)

In polling mode, the sensor only reports readings when requested. The sensor will continue to take measurements in the background, but the output stream is suppressed until data is requested. The sensor will always power up in streaming or polling mode, whichever mode was used before the power cycle.

K COMMAND

Command	Use	Default	Range	Example	Response	Comments
K #\r\n	Switches the sensor between different control modes	1		K 1\r\n	K 1\r\n	See 'K' Commands

Low Power CO₂ Sensor

K COMMAND (0x4B)

Description	Sets the control interface mode
Syntax	ASCII character 'K', SPACE, mode number, terminated by 0x0D 0x0A (CR & LF)
Example	K 1\r\n
Response	K 00001\r\n (this number is variable)

MEASUREMENT DATA OUTPUTS

The CozIR®-LP3 sensor can be configured to provide filtered and unfiltered CO₂ data as a single string of data. The number of data sets being sent by the sensor is configurable using the 'M' command.

UART Command	Use	Default	Range	Example	Response	Comments
M #####\r\n	Sets the number of measurement data types output by the sensor. Set ##### to the mask value	M 00006\r\n		See "Output Fields"	M #####\r\n	Sets the number of measurement data types output by the sensor

Measurement Parameter	Field Identifier	Mask Value
CO ₂ (Filtered)	Z	4
CO ₂ (Unfiltered)	z	2

The CO₂ measurement string is reported as:

Z ##### z #####\r\n

where

Z ##### shows the CO₂ concentration after digitally filtering

and

z ##### shows the instantaneous CO₂ concentration without any digital filtering.

The required mask value is the sum of the 'Mask Value' for each field required. To output filtered and unfiltered CO₂ data, set M=6.

Low Power CO₂ Sensor

UART INTERFACE SUMMARY

Syntax	Use	Example	Response	Comments
A ###\r\n	Set value of the digital filter	A 16\r\n	A 00016\r\n	See “Digital Filter”
a\r\n	Return the value of the digital filter	a\r\n	a 00016\r\n	See “Digital Filter”
c\r\n	Returns total number of hours the sensor powered up	c\r\n	c 00019	
G\r\n	Zero-point setting using fresh air	G\r\n	G 33000\r\n	See “Zero Point Setting”
K #\r\n	Switches the sensor between different modes	K 1\r\n	K 1\r\n	
i\r\n	Self-test error condition	i\r\n	i 85\r\n = no error i 170\r\n = error	
J ###\r\n	PWM control byte	J ###\r\n	J ###\r\n	See “PWM Control”
J\r\n	Read PWM control byte	j\r\n	j ###\r\n	See “PWM Control”
M ###\r\n	Sets the number of measurement data types output by the sensor	M 6\r\n	M 6\r\n	See “Output Fields”
P 8 ###\r\n P 9 #\r\n	Sets value of CO ₂ background concentration in ppm for auto-zeroing	P 8 1\r\n P 9 144\r\n		Two byte value, P 8 = MSB P 9 = LSB

Low Power CO₂ Sensor

Syntax	Use	Example	Response	Comments
				400ppm in the example
P 10 ###\r\n P 11 #\r\n	Sets value of CO ₂ background concentration in ppm used for zero- point zeroing in fresh air.	P 10 1\r\n P 11 144\r\n		Two-byte value, P 10 = MSB P 11 = LSB 400ppm in the example
Q\r\n	Reports the latest measurement data types, as defined by 'M'	Q\r\n	Z 00010\r\n	
U\r\n	Zero-point setting using nitrogen	U\r\n	U 33000\r\n	See "Zero Point Setting"
V #####	Set alarm value	V 15000\r\n	V 15000\r\n	See "Alarm Value"
v\r\n	Read alarm value	v\r\n	v 15000\r\n	
X #####\r\n	Zero-point setting using a known gas calibration	X 2000\r\n	X 32997\r\n	See "Zero Point Setting"
Y\r\n	Return firmware version and sensor serial number	Y\r\n	Returns <u>two</u> lines	
Z\r\n	Return the most recent filtered CO ₂ measurement in ppm	Z\r\n	Z 00521\r\n	

Low Power CO₂ Sensor

Syntax	Use	Example	Response	Comments
z\r\n	Return the most recent unfiltered CO ₂ measurement in ppm	z\r\n	Z 00521\r\n	
@ ## ##\r\n	Sets the timing for initial and interval auto-zero periods	@ 1.0 8.0\r\n	@ 1.0 8.0\r\n	See “Auto-zeroing” for details
@ r\r\n	Returns the Auto-zero configuration	@ 1.0 8.0\r\n	@ 1.0 8.0\r\n	See “Auto-zeroing” for details
@ #r\r\n	Switch Auto-zero on or off	@ 0\r\n	@ 0\r\n	See “Auto-zeroing” for details
.\r\n	Returns the scaling factor multiplier required to convert the Z or z output to ppm	.\r\n	. 00001\r\n	Multiply by 1 in the example
[####\r\n	Set pressure value in mbar	[0997\r\n	[0997\r\n	See “Altitude Pressure Compensation”
] ####\r\n	Read pressure value in mbar	[\r\n	[0997\r\n	See “Altitude Pressure Compensation”

Low Power CO₂ Sensor

CO₂ LEVEL MEASUREMENT VALUE - Z INFORMATION (0x5A)

Description	Reports the latest filtered CO ₂ measurement
Syntax	ASCII Character 'Z', terminated by 0x0D 0x0A (CR & LF)
Example	Z\r\n
Response	Z 00521\r\n

This value needs to be multiplied by the appropriate multiplier to get the ppm value.

CO₂ LEVEL MEASUREMENT VALUE - z INFORMATION (0x7A)

The sensor is also capable of reporting the real time unfiltered CO₂ measurement value.

Description	Reports the unfiltered CO ₂ measurement
Syntax	ASCII Character 'z', terminated by 0x0D 0x0A (CR & LF)
Example	z\r\n
Response	z 00521\r\n

CO₂ MEASUREMENT Z SCALING FACTOR – UART MODE

To calculate the measurement value in ppm, the 'Z' value must be converted into ppm by using the '.' multiplier factor. The multiplier will depend on the full-scale measurement range of the sensor.

Measurement Range of Sensor	CO ₂ Measurement Scaling Factor (Z)	CO ₂ Measurement Output Units	Example
0 – 1%	1	ppm	Z 00521 = 521ppm

'.' COMMAND (0x2E)

To calculate the measurement value in ppm, the 'Z' or 'z' value must be converted into ppm by using the '.' multiplier factor. This multiplier will depend on the full-scale measurement range of the sensor. The multiplier is related to the full-scale range of the sensor. The multiplier must also be used when sending CO₂ concentration levels to the sensor, for example when setting the fresh air CO₂ concentration value. The '.' Command can also be used to read back the scaling factor.

Description	Returns a number indicating what multiplier must be applied to the Z CO ₂ measurement output to convert it into ppm.
Syntax	ASCII character '.', terminated by 0x0D 0x0A (CR & LF)
Example	.\r\n
Response	. 00001\r\n (this number is always 1 for CozIR®-LP3)

Low Power CO₂ Sensor

DIGITAL FILTER COMMANDS

Command	Use	Default	Range	Example	Response	Comments
A ###\r\n	Set value of the digital filter	16	0 - 255	A 16\r\n	A 00016\r\n	
a\r\n	Return value of digital filter		0 - 255	a\r\n	a 00016\r\n	

A COMMAND (0x41)

Description	Set the value of the digital filter
Syntax	ASCII character 'A', SPACE, decimal, terminated by 0x0D 0x0A (CR & LF)
Example	A 16\r\n
Response	A 00016\r\n (this number is variable)

a COMMAND (0x61)

Description	Read the value of the digital filter
Syntax	ASCII character 'A', SPACE, decimal, terminated by 0x0D 0x0A (CR & LF)
Example	A 16\r\n
Response	A 00016\r\n (this number is variable)

Low Power CO₂ Sensor

ZERO SETTING COMMANDS – UART MODE

Command	Use	Default	Range	Example	Response	Comments
G\r\n	Zero-point setting using fresh air			G\r\n	G 33000\r\n	See “Zero Point Setting”
U\r\n	Zero-point setting using nitrogen			U\r\n	U 33000\r\n	See “Zero Point Setting”
X #####\r\n	Zero-point setting using a known gas concentration (in ppm)			X 1000\r\n	X 32997\r\n	See “Zero Point Setting”
P 8 ###\r\n P 9 #\r\n	Sets value of CO ₂ background concentration in ppm for auto-zeroing	P 8 1\r\n P 9 144\r\n		Two-byte value P 8 = MSB P 9 = LSB 400ppm in the example	P 8 ###\r\n P 9 ###\r\n	
P 10 ###\r\n P 11 #\r\n	Sets value of CO ₂ background concentration in ppm used for zero-point setting in fresh air.	P 10 1\r\n P 11 144\r\n		Two-byte value P 10 = MSB P 11 = LSB 400ppm in the example	P 10 ###\r\n P 11 ###\r\n	

Low Power CO₂ Sensor

G COMMAND (0x47)

Description	Sets the zero point assuming the sensor is in fresh air (typically 400ppm CO ₂ , but level can be set by user – see P commands.)
Syntax	ASCII character 'G' terminated by 0x0D 0x0A (CR & LF)
Example	G\r\n
Response	G 33000\r\n (the number is variable)

U COMMAND (0x55)

Description	Sets the zero point assuming the sensor is in 0ppm CO ₂ such as nitrogen.
Syntax	ASCII Character 'U' terminated by 0x0D 0x0A (CR & LF)
Example	U\r\n
Response	U 32767\r\n(the number is variable)

X COMMAND (0x58)

Description	Sets the zero point with the sensor in a known concentration of CO ₂ . Input value is scaled by CO ₂ value multiplier, see '.' command.
Syntax	ASCII character 'X', SPACE, then the gas concentration, terminated by 0x0D (CR & LF)
Example	X 1000\r\n
Response	X 33000\r\n (the number is variable).

P COMMAND - CO₂ Level for Auto-Zeroing

Description	Sets the value of CO ₂ in ppm used for auto-zeroing. Input value is scaled by CO ₂ value multiplier, see '.' command.
Syntax	ASCII character 'P', SPACE, then 8, SPACE, then MSB terminated by 0x0D 0x0A (CR & LF) ASCII character 'P' then a space, then 9, then a space, then LSB terminated by 0x0D 0x0A (CR & LF)
Example	P 8 0\r\n P 9 40\r\n
Response	p 8 0\r\n p 9 40\r\n

The value is entered as a two-byte word, MSB first.

MSB = Integer (Concentration/256)

LSB = Concentration – (256*MSB)

In the above example, target CO₂ background concentration is 400ppm.

MSB = Integer (400/256) = 1

LSB = 400 – 256 = 144

Low Power CO₂ Sensor

P COMMAND – CO₂ Level for Zero-Point Setting

Description	Sets value of CO ₂ in ppm for zero-point setting in fresh air.
Syntax	ASCII character 'P' then a space, then 10, then a space, then MSB terminated by 0x0D 0x0A (CR & LF) ASCII character 'P' then a space, then 11, then a space, then LSB terminated by 0x0D 0x0A (CR & LF)
Example	P 10 7\r\n P 11 208\r\n
Response	P 00010 00007\r\n P 00011 00208\r\n

MSB = Integer (Concentration/256)

LSB = Concentration – (256*MSB)

In the above example, target zero-point CO₂ concentration is 2000ppm.

MSB = Integer (2000/256) = 7

LSB = 2000 – (256*MSB) = 208

Low Power CO₂ Sensor

SENSOR STATUS AND CONFIGURATION COMMANDS – UART MODE

i COMMAND

Description	Reports the result of the sensor self-test.
Syntax	ASCII character 'i' terminated by 0x0D 0x0A (CR & LF)
Example	i\r\n
Response	i ###\r\n (the number is variable) 170 = Sensor error 85 = No sensor error

J COMMAND (0x4A)

Description	Turns PWM output on and off, and sets the PWM output configuration.	
Syntax	ASCII character 'J', SPACE, decimal, terminated by 0x0D 0x0A (CR & LF)	
Example	J 076\r\n	
	BIT	LABEL
	2:0	PRESCALAR Sets clock pre-scaler, in powers 2. Range from 2 to 128
	3	RESOLUTION 0 = 8-bit 1 = 10-bit
	4	MODE 0 = Pulsed 1 = Continuous
	6:5	OUTPUT 00 = Continuous Output 01 = 2 pulses, then sleeps 10 = 4 pulses, then sleeps 11 = 8 pulses, then sleeps
	7	ON/OFF Controls the state of the PWM output 0 = Off 1 = On
	To set PWM output to ON, continuous output (not pulsed), 10-bit resolution, no clock pre-scaler, set value to 1001100 = 076	
Response	J 076\r\n (the number is variable)	

j COMMAND (0x6A)

Description	Reports the PWM configuration.
Syntax	ASCII character 'j' terminated by 0x0D 0x0A (CR & LF)
Example	j\r\n
Response	j ###\r\n (the number is variable)

Low Power CO₂ Sensor

ALTITUDE PRESSURE COMPENSATION

UART Command	Use	Default	Range	Example	Response	Comments
[#####\r\n	Sets the pressure value (mbar)	1013	0-65536	[0990\r\n	[0990\r\n	See "Altitude Pressure Compensation"
]\r\n	Returns the pressure value mbar			[0990\r\n	[0990\r\n	See "Altitude Pressure Compensation"

[COMMAND (0x5B)

Description	Set the altitude pressure value in mbar
Syntax	ASCII character '[', SPACE, decimal, terminated by 0x0D 0x0A (CR & LF)
Example	[0990\r\n
Response	[0990\r\n (the number mirrors the input value)

] COMMAND (0x5D)

Description	Reads the altitude pressure value in mbar
Syntax	ASCII character ']', SPACE, decimal, terminated by 0x0D 0x0A (CR & LF)
Example]\r\n
Response	[0990\r\n (the number mirrors the input value)

Low Power CO₂ Sensor

AUTO-ZERO INTERVALS

UART Command	Use	Default	Range	Example	Response	Comments
@ #.# #.#\r\n	Auto-zero interval settings	7.0 8.0	0.1 to 37.9	@ 1.0 8.0\r\n	@ 1.0 8.0\r\n	See “Auto-Zero” for details

@ COMMAND (0x2E)

Description	Set the ‘Initial Interval’ and ‘Regular Interval’ for auto-zero events.
Syntax	ASCII character '@', SPACE, decimal, SPACE, decimal terminated by 0x0D 0x0A (CR & LF)
Example	@ 1.0 8.0\r\n
Response	@ 1.0 8.0\r\n (the number mirrors the input value)

Both the initial interval and regular interval are given in days. Both must be entered with a decimal point and one figure after the decimal point. In the above example, the auto-zero interval is set to 8 days, and the initial interval set to 1 day.

To disable auto-zeroing, send @ 0\r\n.

To determine the auto-zero configuration, send @\r\n.

Low Power CO₂ Sensor

SERIAL NUMBER AND FIRMWARE VERSION – UART MODE

UART Command	Use	Default	Range	Example	Response	Comments
Y\r\n	Return firmware version and sensor serial number			Y\r\n	Returns <u>two</u> lines	

Y COMMAND (0x59)

Description	The present version string for the firmware and serial number of the sensor.
Syntax	ASCII character 'Y', terminated by 0x0d 0x0a (CR & LF)
Example	Y\r\n
Response	Y, Aug 25 2021,14:19:56,LP15132 B 528148 00000 Where; Aug 25 2021,14:19:56 is the firmware compile date and time LP15132 is the firmware revision 528148 is the sensor ID

N.B. This command returns two lines split by a carriage return line feed and terminated by a carriage return line feed. This command requires that the sensor has been stopped (see 'K' command).

c COMMAND (0x63)

Description	Reports the total number of hours sensor powered up
Syntax	ASCII character 'c', terminated by 0x0d 0x0a (CR & LF)
Example	c\r\n
Response	c #####\r\n where ##### is the number of hours ran

Low Power CO₂ Sensor

CONNECTION DIAGRAM FOR UART INTERFACE

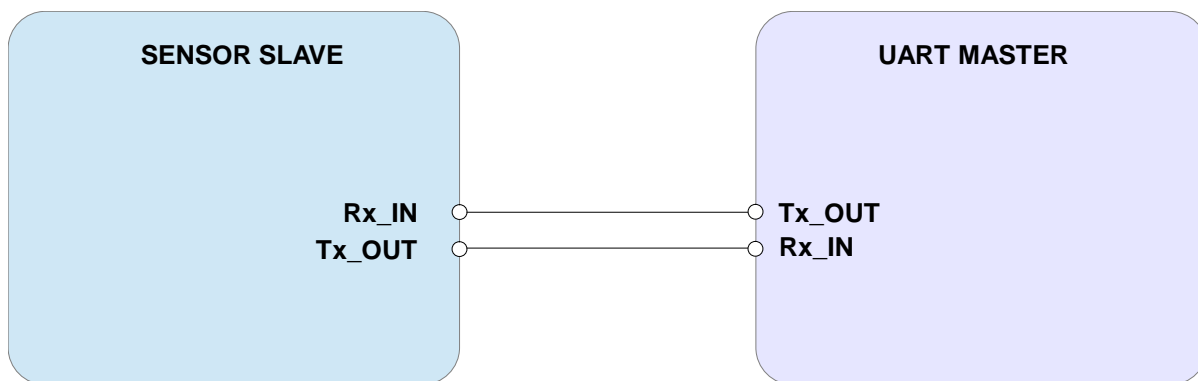

Low Power CO₂ Sensor

IMPORTANT NOTICE

Gas Sensing Solutions Ltd. (GSS) products and services are sold subject to GSS's terms and conditions of sale, delivery and payment supplied at the time of order acknowledgement. GSS warrants performance of its products to the specifications in effect at the date of shipment. GSS reserves the right to make changes to its products and specifications or to discontinue any product or service without notice.

Customers should therefore obtain the latest version of relevant information from GSS to verify that the information is current. Testing and other quality control techniques are utilised to the extent GSS deems necessary to support its warranty. Specific testing of all parameters of each device is not necessarily performed unless required by law or regulation. In order to minimise risks associated with customer applications, the customer must use adequate design and operating safeguards to minimise inherent or procedural hazards. GSS is not liable for applications assistance or customer product design. The customer is solely responsible for its selection and use of GSS products. GSS is not liable for such selection or use nor for use of any circuitry other than circuitry entirely embodied in a GSS product.

GSS products are not intended for use in life support systems, appliances, nuclear systems or systems where malfunction can reasonably be expected to result in personal injury, death or severe property or environmental damage. Any use of products by the customer for such purposes is at the customer's own risk.

GSS does not grant any licence (express or implied) under any patent right, copyright, mask work right or other intellectual property right of GSS covering or relating to any combination, machine, or process in which its products or services might be or are used. Any provision or publication of any third party's products or services does not constitute GSS's approval, licence, warranty or endorsement thereof. Any third-party trademarks contained in this document belong to the respective third-party owner.

Reproduction of information from GSS datasheets is permissible only if reproduction is without alteration and is accompanied by all associated copyright, proprietary and other notices (including this notice) and conditions. GSS is not liable for any unauthorised alteration of such information or for any reliance placed thereon.

Any representations made, warranties given, and/or liabilities accepted by any person which differ from those contained in this datasheet or in GSS's standard terms and conditions of sale, delivery and payment are made, given and/or accepted at that person's own risk. GSS is not liable for any such representations, warranties or liabilities or for any reliance placed thereon by any person.