

COZIR™ LP

Low Power, Low Profile Carbon Dioxide Sensor

COZIR LP is a low profile, low power, high performance CO₂ sensor. Operating at a 2Hz update rate while only consuming 3mW⁵, its world leading power consumption make it ideally suited for battery operation and portable instruments. Based on proven GSS IR LED and Detector technology and innovative optical designs. **COZIR LP** is a third generation product from Gas Sensing Solutions Ltd – leaders in IR LED CO₂ sensing.

With measurement ranges of 0-2000ppm, 0-5000ppm and 0-1% the **COZIR LP** Sensor is suitable for applications such as **Building Control** and **Indoor Air Quality**.

- Ultra-low Power 3mW
- Measurement ranges from 0 to 1%
- 3.3V supply
- Peak current only 33mA
- Commands set and electrical interface compatible with GSS COZIR sensor range.

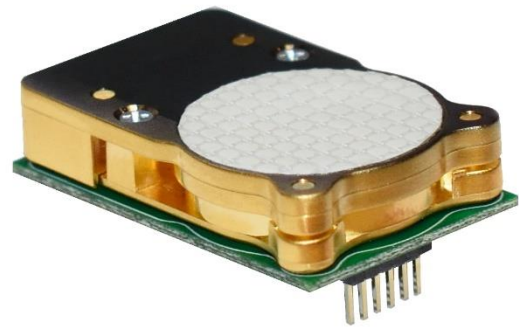

COZIR™ LP CO₂ Sensor

Specifications

General Performance	
Start up time	First reading 1.2s after power on ²
Operating Conditions	0°C to 50°C (Standard) -25°C to 55°C (Extended range) 0 to 95% RH, non-condensing
Recommended Storage	-30°C to +70°C
CO ₂ Measurement	
Sensing Method	Non-dispersive infrared (NDIR) absorption Patented Gold-plated optics Proprietary GSS Solid-state source and detector
Sample Method	Diffusion
Measurement Range	0-5000ppm standard. 0-2000ppm and 0-1% on request.
Accuracy	±50 ppm +/- 3% of reading ¹
Calibration	Autocalibration ⁶
Non Linearity	< 1% of FS
Pressure Dependence	0.13% of reading per mm Hg in normal atmospheric conditions.
Operating Pressure Range	950 mbar to 1050 mbar ³
Response Time	2- 3 mins (Configurable via filter type and application) ³ Reading refreshed twice per second.

Electrical/ Mechanical	
Power Input	3.25 to 5.5V. (3.3V recommended). Peak Current 33mA ⁵ . Average Current <1mA ⁵ .
Connector	6-way 1.27mm header
Power Consumption	3 mW ⁵
Interface	UART
Weight	5g
Dimensions	31mm x 19.5mm x 8mm ⁷

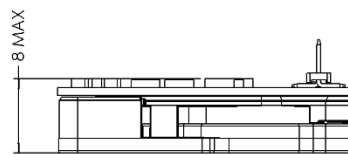
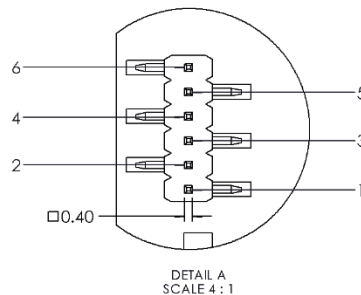
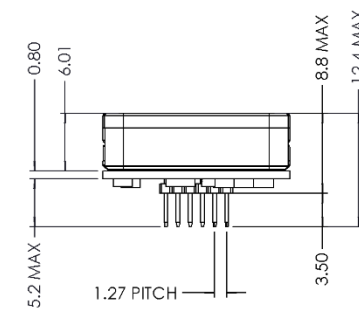
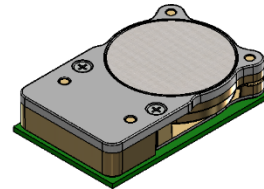
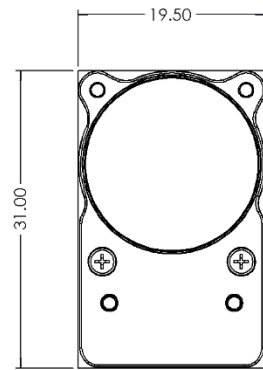

FUNCTION	PIN #
GND	1
Vsupply	2
Rx IN	3
Tx OUT	4
N/C	5
N/C	6

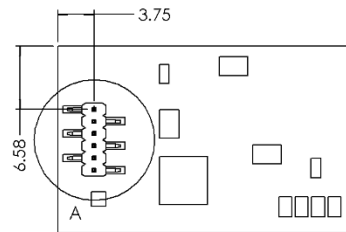

Note 1: All measurements are at STP unless otherwise stated.

Note 2: There is no sensor warm-up as the sensor has no heated parts. Longer integration time will reduce measurement noise.

Note 3: External Pressure calibration required.

Note 4: User Configurable Filter Response.

Note 5: Power measurements with sensor operated in polling mode.

Note 6: Autocalibration is enabled by default on COZIR-LP. For correct operation, the sensor must experience concentrations close to fresh air. For details request the application note "COZIR Autocalibration".

Note 7: Excludes height of connector pins.

This documentation is provided on an as-is basis and no warranty as to its suitability or accuracy for any particular purpose is either made or implied. Gas Sensing Solutions Ltd will not accept any claim for damages howsoever arising as a result of use or failure of this information. Your statutory rights are not affected. This information is not intended for use in any medical appliance, device or system in which the failure of the product might reasonably be expected to result in personal injury. This document provides preliminary information that may be subject to change without notice.